



UFO HIGH BAY LIGHT

UFO Series

■ ADVANTAGE

- Watt switchable:
80W/100W/150W 150W/200W/240W
- CCT switchable: 4000K/5000K
- Long lifespan with $L70 > 100,000$ hrs @ $T_a = 25^\circ\text{C}$
- Cost effective design makes it more competitive
- Patent design—All the LEDs are light up even when it is in CCT mode, provide even light
- Ambient working temperature: $-40^\circ\text{C}/-40^\circ\text{F}$ to $50^\circ\text{C}/122^\circ\text{F}$
- Applications: factory, workshop, warehouse, etc



■ DETAILS

Features

- Solid structure, Die-casting aluminum housing ensures excellent heat dissipation.
- Wattage and CCT switchable through dip-switches.
- High-quality LEDs, provide bright and uniform lighting.
- Housing color options: black, white.

Installations

- Durable round hanging ring, can be hung anywhere.
- Suspend the UFO High Bay by using US hook or U Bracket.
- The fixture comes with a safety rope added an additional protection for the installation.

Certifications

- DLC premium.
- Comply with the requirements of the Standard(s) for Luminaires and are identified with the cETL Listed Mark.

Accessories

- Emergency battery , motion sensor etc available.

Warranty

- All products are guaranteed with 5 years' warranty.
- See Warranty policy for additional information.

■ DIMENSIONS

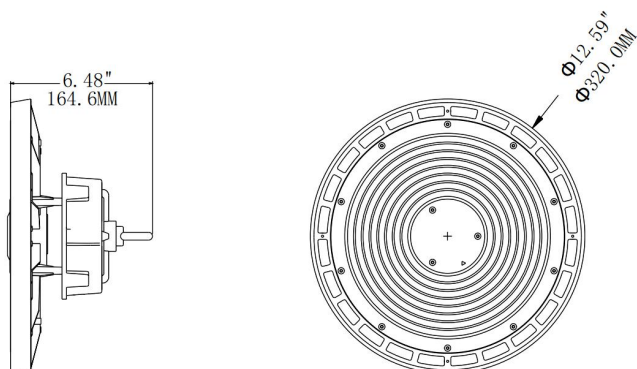

Small size

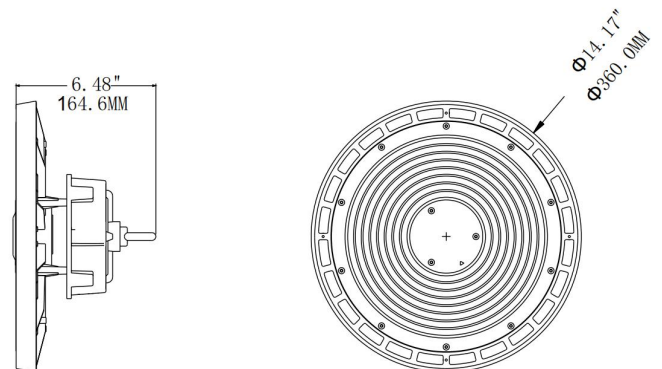

Large size

UFO HIGH BAY LIGHT

■ SPECIFICATION

	MODEL	SIZE	WATT	CCT	LUMEN	EFFICACY
<input type="checkbox"/>	DM-UF80/100/150W-BNN45	S	80W/100W/150W switchable	4000K/5000K switchable	12800Lm 16000Lm 24000Lm	160Lm/W
<input type="checkbox"/>	DM-UF150/200/240W - BNN45	L	150W/200W/240W switchable	4000K/5000K switchable	24000Lm 32000Lm 38400Lm	160Lm/W

■ ACCESSORIES (order separately)

- Motion Sensor
- Remote Controller

- Emergency Battery
- PC Reflector

- U Bracket
- US Hook



Emergency Battery

- UL listed approved
- AC solution EM for 9-350W LED luminaire
- Charging time: 24 hours
- Selectable emergency power: 30W, 40W
- Illumination time: 90 minutes



Microwave Sensor

- Input Voltage: 12VDC
- Output Dimming: 0-10V
- Detection Distance: 10ft
- Working Temp: -25° C~+60° C
- IP Rate: IP65



60° Anti-Glare PC Reflector

- Specially Designed for UFO High Bay, Available in small and large size
- Make the light more concentrated
- This reflector can effectively reduce glare, making your lights look softer and more comfortable



U Bracket

- Adjust the angle of the lamp according to your needs
- Easy installation, illuminate every place



US hook

- Durable standard US hook
- Hang the light fixture to anywhere you want

UFO HIGH BAY LIGHT

PACKING INFO

SIZE	1PCS/CARTON			CONTAINER		
	DIMENSION(INCH)	N.W(LBS)	G.W(LBS)	20'GP(PCS)	40'GP(PCS)	40HQ(PCS)
S	12.80" x12.80" x5.12"	5.29	5.73	2410	4992	5853
L	14.37" x14.37" x5.12"	6.5	6.94	1616	3349	3926

INSTALLATIONS

❖ Rings mounted

1. Attach the lifting ring to the fixture and fasten it with screws.
2. Loosen the rubber plug (B), adjust the corresponding power and color temperature, install the rubber plug (B), loosen the cross nut (C) as required, and then install the sensor (D).

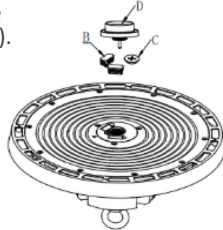
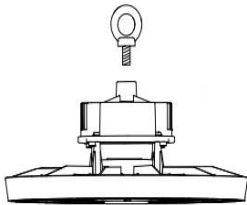

3. Fix the lamps and safety buckles on the hooks respectively.

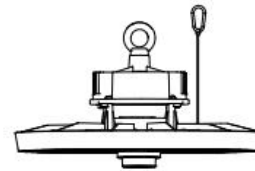

4. Electric and power input line connection (Black wire- L, White wire - N, Green wire - E, Purple-1-10V+, Pink-1-10V-).

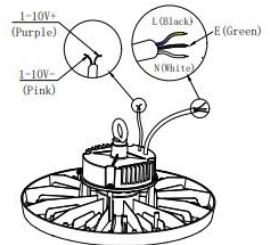

❖ Surface mounted

1. Fasten the bracket to the fixture with screws, loosen the nuts (A) at both ends, adjust the bracket to the required angle, and then lock it with the nuts (A) after confirmation.

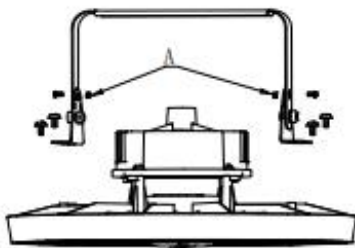

2. Loosen the rubber plug (B), adjust the corresponding power and color temperature, install the rubber plug (B), loosen the cross nut (C) as required, and then install the sensor (D).

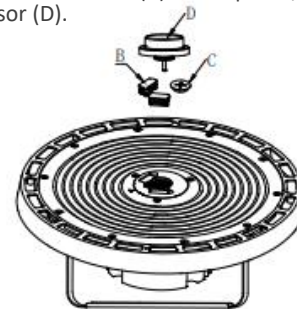

3. Drill two holes on the ceiling according to the hole spacing (A) on the bracket, install the expansion rubber plugs into the holes, and fix the fixture on the ceiling with screws through the bracket.

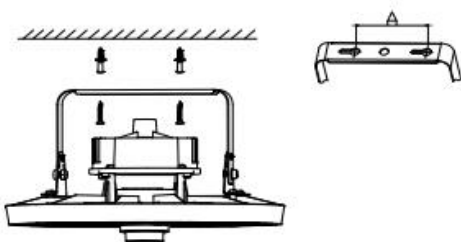

4. Electric and power input line connection (Black wire- L, White wire - N, Green wire - E, Purple-1-10V+, Pink-1-10V-).

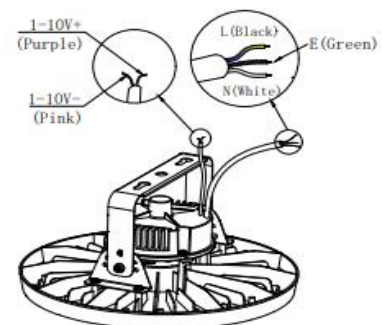

UFO HIGH BAY LIGHT

PHOTOMETRIC DATA

DM-UF80/100/150W- BNN45

Watt	160 W
PF	0.9980
CRI	≧ 80
THD	≧ 20%
Flux	22500.3 lm
Efficacy (AC)	160 lm/w
CCT	5000K
Voltage Range	120-277 V
Operating Temperature	-40°C to 50°C

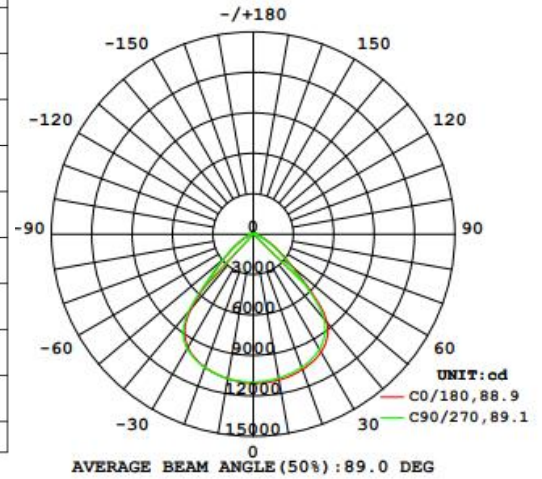
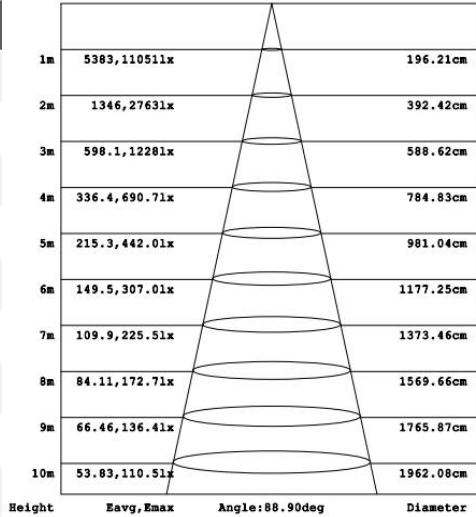

DM-UF150/200/240W- BNN45

Watt	240 W
PF	0.9980
CRI	≧ 80
THD	20.8%
Flux	36000.6 lm
Efficacy (AC)	160 lm/w
Maximum CCT	5000K
Voltage Range	120-277 V
Operating Temperature	30°C to 130°C

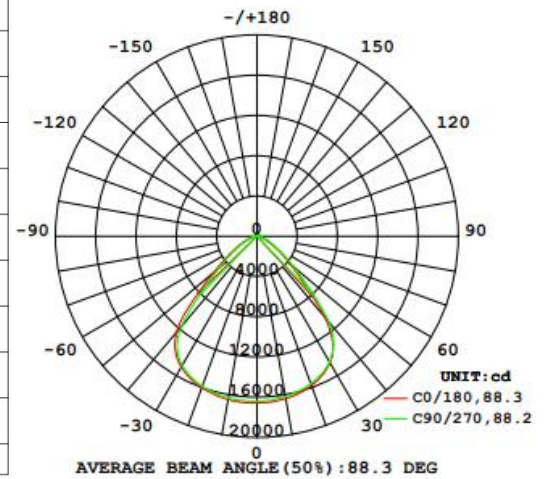
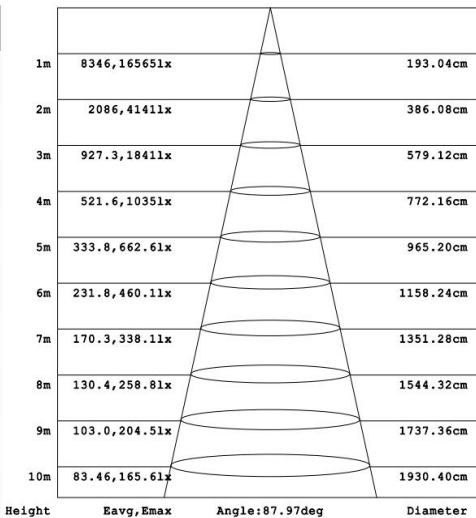

APPLICATION

